

Фитинги резьбовые

Фитинг прямой с наружной резьбой Мод. X2500

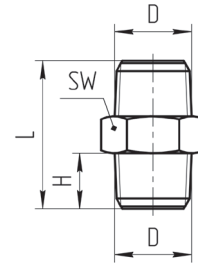

РАЗМЕРЫ

Мод.	D	H	L	SW
X2500 1/8 SS316	R1/8	7,5	20	12
X2500 1/4 SS316	R1/4	10,5	26	14
X2500 3/8 SS316	R3/8	11	27	17
X2500 1/2 SS316	R1/2	13	31	21
X2500 3/4 SS316	R3/4	15	36	27

Фитинг прямой с наружной резьбой переходной Мод. X2510

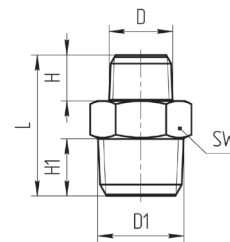

РАЗМЕРЫ

Мод.	D	D1	H	H1	L	SW
X2510 1/8-1/4 SS316	R1/8	R1/4	7,5	10,5	23	14
X2510 1/8-3/8 SS316	R1/8	R3/8	7,5	11	23,5	17
X2510 1/4-3/8 SS316	R1/4	R3/8	10,5	11	26,5	17
X2510 1/4-1/2 SS316	R1/4	R1/2	10,5	13	28,5	21
X2510 3/8-1/2 SS316	R3/8	R1/2	11	13	29	21
X2510 1/2-3/4 SS316	R1/2	R3/4	13	15	32	27

Фитинг прямой с наружной резьбой Мод. X2502

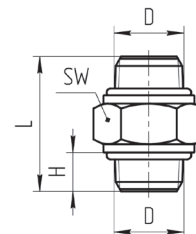

РАЗМЕРЫ

Мод.	D	H	L	SW
X2502 M5 SS316	M5	3	14	8
X2502 1/8 SS316	G1/8	5,5	20	14
X2502 1/4 SS316	G1/4	6,5	22	17
X2502 3/8 SS316	G3/8	7,5	24	21
X2502 1/2 SS316	G1/2	9	27	24

Фитинг прямой с наружной резьбой переходной Мод. X2512

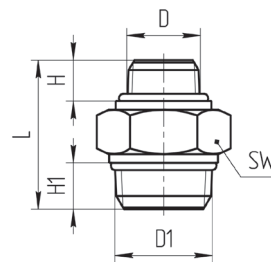

РАЗМЕРЫ

Мод.	D	D1	H	H1	L	SW
X2512 1/8-1/4 SS316	G1/8	G1/4	5,5	6,5	21	17
X2512 1/8-3/8 SS316	G1/8	G3/8	5,5	7,5	22	21
X2512 1/4-3/8 SS316	G1/4	G3/8	6,5	7,5	23	21
X2512 1/4-1/2 SS316	G1/4	G1/2	6,5	9	24,5	24
X2512 3/8-1/2 SS316	G3/8	G1/2	7,5	9	24,5	24

Фитинг прямой переходной Мод. X2530

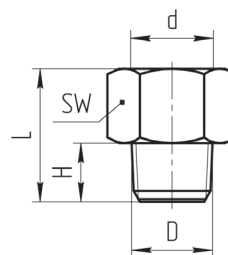

РАЗМЕРЫ

Мод.	D	d	H	L	SW
X2530 1/8-1/8 SS316	R1/8	G1/8	7,5	17	14
X2530 1/4-1/8 SS316	R1/4	G1/8	10,5	15,5	14
X2530 3/8-1/8 SS316	R3/8	G1/8	11	16	17
X2530 1/2-1/8 SS316	R1/2	G1/8	13	18	21
X2530 3/8-1/4 SS316	R3/8	G1/4	11	16	17
X2530 1/2-1/4 SS316	R1/2	G1/4	13	18	21
X2530 1/2-3/8 SS316	R1/2	G3/8	13	18	21
X2530 3/4-3/8 SS316	R3/4	G3/8	15	21	27
X2530 3/4-1/2 SS316	R3/4	G1/2	15	21	27

Фитинг прямой переходной Мод. X2520

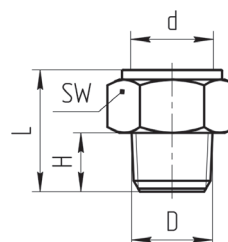

РАЗМЕРЫ

Мод.	D	d	H	L	SW
X2520 1/8-1/8 SS316	R1/8	G1/8	7,5	15,5	14
X2520 1/8-1/4 SS316	R1/8	G1/4	7,5	18	17
X2520 1/8-3/8 SS316	R1/8	G3/8	7,5	18,5	19
X2520 1/4-1/4 SS316	R1/4	G1/4	10,5	21	17
X2520 1/4-3/8 SS316	R1/4	G3/8	10,5	21,5	19
X2520 1/4-1/2 SS316	R1/4	G1/2	10,5	23,5	24
X2520 3/8-3/8 SS316	R3/8	G3/8	11	22	19
X2520 3/8-1/2 SS316	R3/8	G1/2	11	24	24
X2520 1/2-1/2 SS316	R1/2	G1/2	13	26	24

Фитинг прямой переходной Мод. X2522

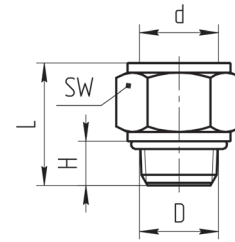

РАЗМЕРЫ

Мод.	D	d	H	L	SW
X2522 M5-1/8 SS316	M5	G1/8	4	14	14
X2522 1/8-1/8 SS316	G1/8	G1/8	5,5	16	14
X2522 1/8-1/4 SS316	G1/8	G1/4	5,5	17,5	17
X2522 1/8-3/8 SS316	G1/8	G3/8	5,5	18,5	19
X2522 1/4-1/4 SS316	G1/4	G1/4	6,5	19,5	17
X2522 1/4-3/8 SS316	G1/4	G3/8	6,5	20,5	19
X2522 1/4-1/2 SS316	G1/4	G1/2	6,5	24,5	24
X2522 3/8-3/8 SS316	G3/8	G3/8	7,5	21,5	19
X2522 3/8-1/2 SS316	G3/8	G1/2	7,5	25,5	24
X2522 1/2-1/2 SS316	G1/2	G1/2	9	26,5	24

Фитинг прямой переходной Мод. X2521

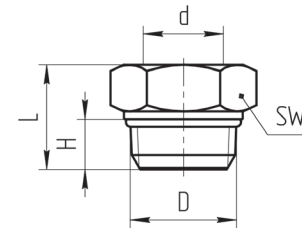

РАЗМЕРЫ

Мод.	D	d	H	L	SW
X2521 1/8-M5 SS316	G1/8	M5	5,5	12,5	14
X2521 1/4-1/8 SS316	G1/4	G1/8	6,5	13,5	17
X2521 3/8-1/8 SS316	G3/8	G1/8	7,5	14,5	21
X2521 3/8-1/4 SS316	G3/8	G1/4	7,5	14,5	21
X2521 1/2-1/8 SS316	G1/2	G1/8	9	16	24
X2521 1/2-1/4 SS316	G1/2	G1/4	9	16	24
X2521 1/2-3/8 SS316	G1/2	G3/8	9	16	24

Фитинг соединитель прямой с внутренней резьбой Мод. X2543

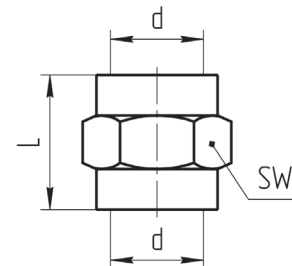

РАЗМЕРЫ

Мод.	d	L	SW
X2543 M5 SS316	M5	11	8
X2543 1/8 SS316	G1/8	15	14
X2543 1/4 SS316	G1/4	22	17
X2543 3/8 SS316	G3/8	23	19
X2543 1/2 SS316	G1/2	26	24

Фитинг переходной прямой с внутренней резьбой Мод. X2543

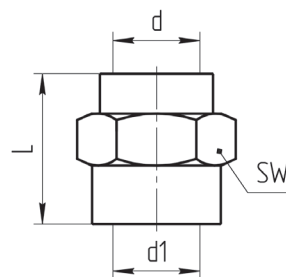

РАЗМЕРЫ				
Мод.	d	d1	L	SW
X2543 M5-1/8 SS316	M5	G1/8	12,5	14
X2543 1/8-1/4 SS316	G1/8	G1/4	18	17
X2543 1/8-3/8 SS316	G1/8	G3/8	18,5	19
X2543 1/8-1/2 SS316	G1/8	G1/2	20,5	24
X2543 1/4-3/8 SS316	G1/4	G3/8	21,5	19
X2543 1/4-1/2 SS316	G1/4	G1/2	23,5	24
X2543 3/8-1/2 SS316	G3/8	G1/2	24	24

Фитинг угловой с наружной резьбой Мод. X2010

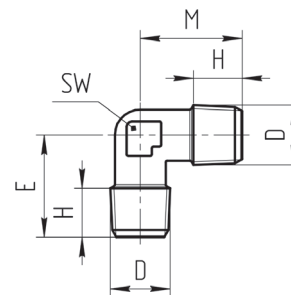

РАЗМЕРЫ					
Мод.	D	H	E	M	SW
X2010 M5 SS316	M5	9	20	20	9,2
X2010 1/8 SS316	R1/8	12,5	24	24	11,2
X2010 1/4 SS316	R1/4	17	26	26	13,2
X2010 3/8 SS316	R3/8	20	30	30	15,5
X2010 1/2 SS316	R1/2	24	34	34	20,6

Фитинг угловой переходной Мод. X2020

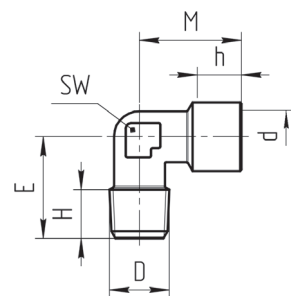

РАЗМЕРЫ							
Мод.	D	d	h	H	E	M	SW
X2020 M5 SS316	M5	M5	9	9	20	20	9,2
X2020 1/8 SS316	R1/8	G1/8	12,5	12,5	24	24	11,2
X2020 1/4 SS316	R1/4	G1/4	17	17	26	26	13,2
X2020 3/8 SS316	R3/8	G3/8	20	20	30	30	15,5
X2020 1/2 SS316	R1/2	G1/2	24	24	34	34	20,6

Фитинг угловой с внутренней резьбой Мод. X2013

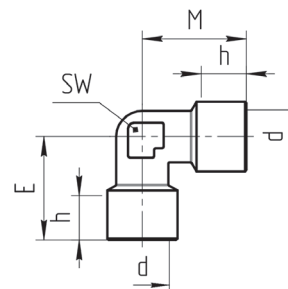

РАЗМЕРЫ					
Мод.	d	h	E	M	SW
X2013 M5 SS316	M5	9	20	20	9,2
X2013 1/8 SS316	G1/8	12,5	24	24	11,2
X2013 1/4 SS316	G1/4	17	26	26	13,2
X2013 3/8 SS316	G3/8	20	30	30	15,5
X2013 1/2 SS316	G1/2	24	34	34	20,6

Фитинг тройник с наружной резьбой Мод. X2080

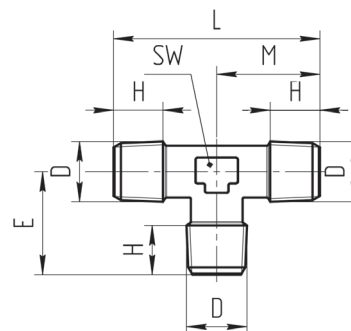

РАЗМЕРЫ						
Мод.	D	H	E	M	L	SW
X2080 M5 SS316	M5	9	20	20	40	9,2
X2080 1/8 SS316	R1/8	12,5	24	24	48	11,2
X2080 1/4 SS316	R1/4	17	26	26	52	13,2
X2080 3/8 SS316	R3/8	20	30	30	60	15,5
X2080 1/2 SS316	R1/2	24	34	34	68	20,6

Фитинг тройник переходной Мод. X2090

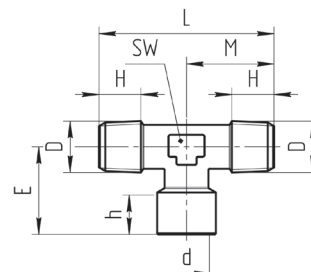

РАЗМЕРЫ								
Мод.	D	d	h	H	E	M	L	SW
X2090 M5 SS316	M5	M5	9	9	20	20	40	9,2
X2090 1/8 SS316	R1/8	G1/8	12,5	12,5	24	24	48	11,2
X2090 1/4 SS316	R1/4	G1/4	17	17	26	26	52	13,2
X2090 3/8 SS316	R3/8	G3/8	20	20	30	30	60	15,5
X2090 1/2 SS316	R1/2	G1/2	24	24	34	34	68	20,6

Фитинг тройник переходной Мод. X2050

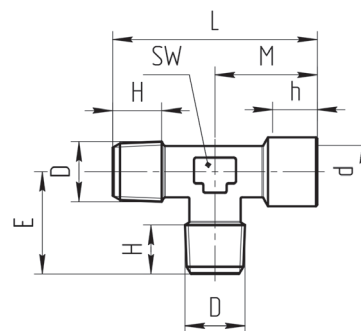

РАЗМЕРЫ								
Мод.	D	d	h	H	E	M	L	SW
X2050 M5 SS316	M5	M5	9	9	20	20	40	9,2
X2050 1/8 SS316	R1/8	G1/8	12,5	12,5	24	24	48	11,2
X2050 1/4 SS316	R1/4	G1/4	17	17	26	26	52	13,2
X2050 3/8 SS316	R3/8	G3/8	20	20	30	30	60	15,5
X2050 1/2 SS316	R1/2	G1/2	24	24	34	34	68	20,6

Фитинг тройник переходной Мод. X2060

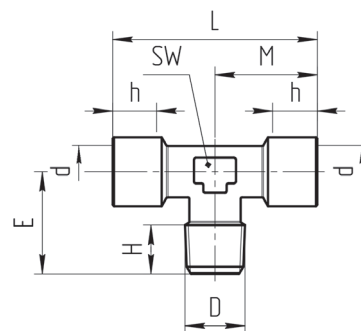

РАЗМЕРЫ								
Мод.	D	d	h	H	E	M	L	SW
X2060 M5 SS316	M5	M5	9	9	20	20	40	9,2
X2060 1/8 SS316	R1/8	G1/8	12,5	12,5	24	24	48	11,2
X2060 1/4 SS316	R1/4	G1/4	17	17	26	26	52	13,2
X2060 3/8 SS316	R3/8	G3/8	20	20	30	30	60	15,5
X2060 1/2 SS316	R1/2	G1/2	24	24	34	34	68	20,6

Фитинг тройник переходной Мод. X2070

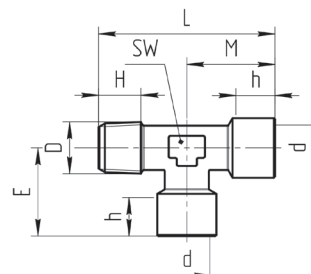

РАЗМЕРЫ								
Мод.	D	d	h	H	E	M	L	SW
X2070 M5 SS316	M5	M5	9	9	20	20	40	9,2
X2070 1/8 SS316	R1/8	G1/8	12,5	12,5	24	24	48	11,2
X2070 1/4 SS316	R1/4	G1/4	17	17	26	26	52	13,2
X2070 3/8 SS316	R3/8	G3/8	20	20	30	30	60	15,5
X2070 1/2 SS316	R1/2	G1/2	24	24	34	34	68	20,6

Фитинг тройник с внутренней резьбой Мод. X2003

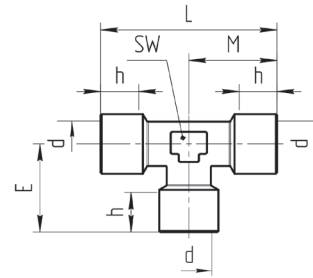
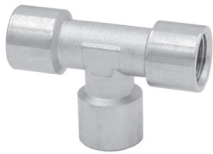

РАЗМЕРЫ

Мод.	d	h	E	M	L	SW
X2003 M5 SS316	M5	9	20	20	40	9,2
X2003 1/8 SS316	G1/8	12,5	24	24	48	11,2
X2003 1/4 SS316	G1/4	17	26	26	52	13,2
X2003 3/8 SS316	G3/8	20	30	30	60	15,5
X2003 1/2 SS316	G1/2	24	34	34	68	20,6

Фитинг тройник Y-образный переходной Мод. X2540

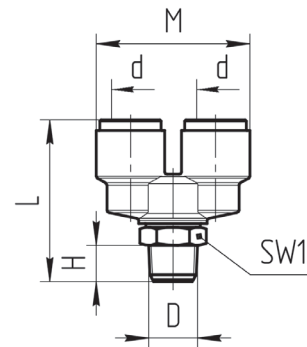

РАЗМЕРЫ

Мод.	d	D	H	M	L	SW
X2540 1/8-1/8 SS316	G1/8	R1/8	7,5	32,1	33,5	12
X2540 1/8-1/4 SS316	G1/8	R1/4	10,5	32,1	35,5	14
X2540 1/8-3/8 SS316	G1/8	R3/8	11	32,1	36,5	17
X2540 1/8-1/2 SS316	G1/8	R1/2	13	32,1	38,5	21
X2540 1/4-1/8 SS316	G1/4	R1/8	7,5	38,3	35,5	12
X2540 1/4-1/4 SS316	G1/4	R1/4	10,5	38,3	37,5	14
X2540 1/4-3/8 SS316	G1/4	R3/8	11	38,3	38,5	17
X2540 1/4-1/2 SS316	G1/4	R1/2	13	38,3	40,5	21
X2540 3/8-1/8 SS316	G3/8	R1/8	7,5	44,1	42	12
X2540 3/8-1/4 SS316	G3/8	R1/4	10,5	44,1	44	14
X2540 3/8-3/8 SS316	G3/8	R3/8	11	44,1	45	17
X2540 3/8-1/2 SS316	G3/8	R1/2	13	44,1	47	21
X2540 1/2-1/8 SS316	G1/2	R1/8	7,5	53	49	12
X2540 1/2-1/4 SS316	G1/2	R1/4	10,5	53	51	14
X2540 1/2-3/8 SS316	G1/2	R3/8	11	53	52	17
X2540 1/2-1/2 SS316	G1/2	R1/2	13	53	54	21

Фитинг тройник Y-образный с внутренней резьбой Мод. X2043

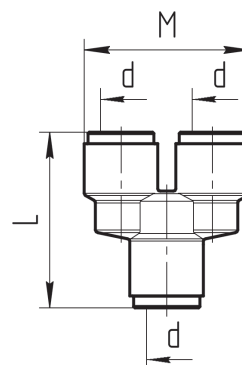

РАЗМЕРЫ			
Мод.	d	M	L
X2043 1/8 SS316	G1/8	32,1	33,6
X2043 1/4 SS316	G1/4	38,3	35,5
X2043 3/8 SS316	G3/8	44,1	42
X2043 1/2 SS316	G1/2	53	49

Заглушка с наружной резьбой Мод. X2610

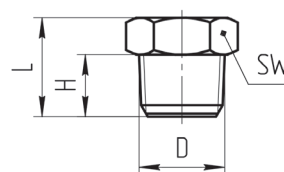

РАЗМЕРЫ				
Мод.	D	H	L	SW
X2610 1/8 SS316	R1/8	7,5	12,5	12
X2610 1/4 SS316	R1/4	9,5	15,5	14
X2610 3/8 SS316	R3/8	10,5	16	17
X2610 1/2 SS316	R1/2	12,5	18	21
X2610 3/4 SS316	R3/4	15	21	27

Заглушка с наружной резьбой Мод. X2612

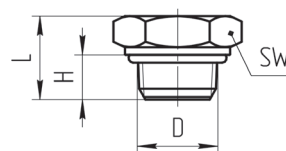

РАЗМЕРЫ				
Мод.	D	H	L	SW
X2612 M5 SS316	M5	4	7,5	8
X2612 1/8 SS316	G1/8	5,5	10,5	14
X2612 1/4 SS316	G1/4	6,5	11,5	17
X2612 3/8 SS316	G3/8	7,5	12,5	21
X2612 1/2 SS316	G1/2	9	14	24

Заглушка с наружной резьбой Мод. X2615

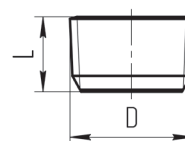

РАЗМЕРЫ		
Мод.	D	L
X2615 1/8 SS316	G1/8	7
X2615 1/4 SS316	G1/4	9
X2615 3/8 SS316	G3/8	10
X2615 1/2 SS316	G1/2	12

