

Фитинги с накидной гайкой из нержавеющей стали 316L

Серия X1000-SS316

Под трубопровод с внешними диаметрами: 4, 6, 8, 10, 12, 14, 16 мм.

Присоединение: метрическая резьба (M5, M6),
BSP (G1/8, G1/4, G3/8, G1/2),
BSPT (R1/8, R1/4, R3/8, R1/2),
NPT (по запросу).

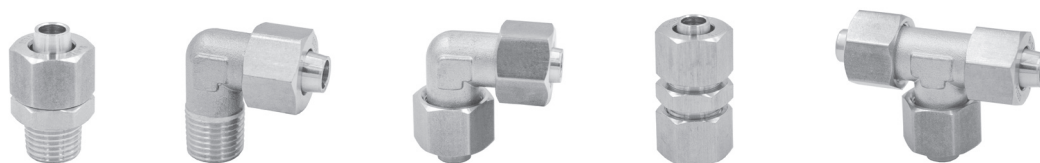

Фитинги с накидной гайкой из нержавеющей стали AISI 316 серии X1000 разработаны для использования в агрессивных средах.

Конструкция фитинга обеспечивает надежную фиксацию при воздействии негативных факторов, включая вибрацию.

Специальная форма конуса сохраняет целостность трубопровода при соединении, а отсутствие уплотнительных элементов позволяет использовать фитинги в расширенном диапазоне температур.

Серия X1000 может применяться в химической, фармацевтической, пищевой и упаковочной промышленности.

ОСНОВНЫЕ ХАРАКТЕРИСТИКИ

Материалы	нержавеющая сталь AISI316
Резьба	M5, M6, коническая ISO 7 (BSPT), цилиндрическая ISO 228 (BSP), NPT (по запросу)
Трубопроводы для присоединения	полиэстер, полиамид, полиэтилен, полиуретан, PTFE, поливинилхлорид в оплетке PVC
Внешний диаметр трубопровода	∅ 4, 6, 8, 10, 12, 14, 16 мм
Рабочее давление	до 25 бар
Рабочая среда	сжатый воздух, вода, агрессивная среда (для использования с другими средами, пожалуйста, обратитесь к инженерам Камоцци)
Температура	-60°C ÷ +240°C

ПРИМЕР МОНТАЖА

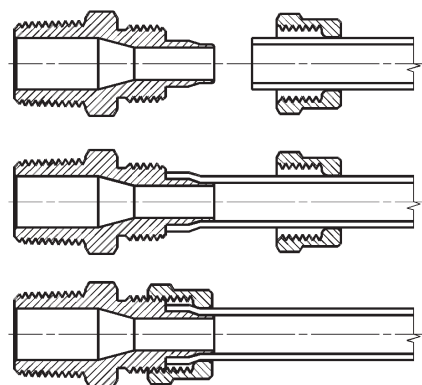

Фитинг прямой с наружной резьбой Мод. X1510

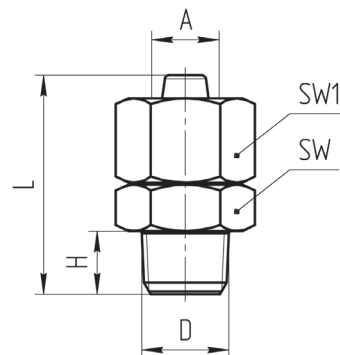

РАЗМЕРЫ						
Мод.	A	D	H	L	SW	SW1
X1510 4/2.5-M5 SS316	4	M5	4	23	10	10
X1510 4/2.5-M6 SS316	4	M6	4	23	10	10
X1510 4/2.5-1/8 SS316	4	R1/8	4	23	10	10
X1510 6/4-M5 SS316	6	M5	4	23	12	12
X1510 6/4-M6 SS316	6	M6	4	23	12	12
X1510 6/4-1/8 SS316	6	R1/8	7,5	25	12	12
X1510 6/4-1/4 SS316	6	R1/4	9,5	27	14	12
X1510 8/6-1/8 SS316	8	R1/8	7,5	26	14	14
X1510 8/6-1/4 SS316	8	R1/4	9,5	28	14	14
X1510 8/6-3/8 SS316	8	R3/8	10,5	29	17	14
X1510 8/6-1/2 SS316	8	R1/2	12,5	31	21	14
X1510 10/8-1/8 SS316	10	R1/8	7,5	28,5	17	16
X1510 10/8-1/4 SS316	10	R1/4	9,5	30,5	17	16
X1510 10/8-3/8 SS316	10	R3/8	10,5	31,5	17	16
X1510 10/8-1/2 SS316	10	R1/2	12,5	33,5	21	16
X1510 12/10-1/8 SS316	12	R1/8	7,5	30,5	21	19
X1510 12/10-1/4 SS316	12	R1/4	9,5	31,5	21	19
X1510 12/10-3/8 SS316	12	R3/8	10,5	33,5	21	19
X1510 12/10-1/2 SS316	12	R1/2	12,5	35,5	21	19
X1510 14/11-1/4 SS316	14	R1/4	9,5	34,5	22	21
X1510 14/11-3/8 SS316	14	R3/8	10,5	35,5	22	21
X1510 14/11-1/2 SS316	14	R1/2	12,5	37,5	22	21
X1510 16/13-3/8 SS316	16	R3/8	10,5	37,5	24	22
X1510 16/13-1/2 SS316	16	R1/2	12,5	39,5	24	22

Фитинг прямой с внутренней резьбой Мод. X1463

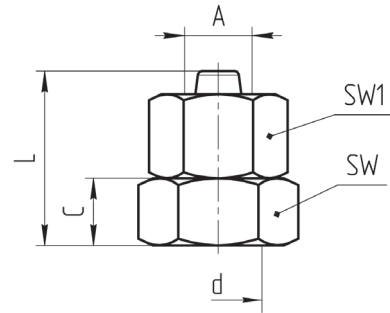

РАЗМЕРЫ						
Мод.	A	d	C	L	SW	SW1
X1463 4/2.5-M5 SS316	4	M5	5	24	12	10
X1463 4/2.5-M6 SS316	4	M6	5	24	12	10
X1463 4/2.5-1/8 SS316	4	G1/8	8	24	12	10
X1463 6/4-M5 SS316	6	M5	5	24	14	12
X1463 6/4-M6 SS316	6	M6	5	24	14	12
X1463 6/4-1/8 SS316	6	G1/8	8	26	14	12
X1463 6/4-1/4 SS316	6	G1/4	11	28,5	17	12
X1463 8/6-1/8 SS316	8	G1/8	8	27	17	14
X1463 8/6-1/4 SS316	8	G1/4	11	29,5	17	14
X1463 8/6-3/8 SS316	8	G3/8	12	30,5	21	14
X1463 8/6-1/2 SS316	8	G1/2	14	32,5	24	14
X1463 10/8-1/8 SS316	10	G1/8	8	29	17	16
X1463 10/8-1/4 SS316	10	G1/4	11	32	17	16
X1463 10/8-3/8 SS316	10	G3/8	12	33	21	16
X1463 10/8-1/2 SS316	10	G1/2	14	35	24	16
X1463 12/10-1/8 SS316	12	G1/8	8	31,5	19	16
X1463 12/10-1/4 SS316	12	G1/4	11	34	21	16
X1463 12/10-3/8 SS316	12	G3/8	12	35	21	16
X1463 12/10-1/2 SS316	12	G1/2	14	37	24	16
X1463 14/11-1/4 SS316	14	G1/4	11	36	22	19
X1463 14/11-3/8 SS316	14	G3/8	12	37	24	19
X1463 14/11-1/2 SS316	14	G1/2	14	39	24	19
X1463 16/13-3/8 SS316	16	G3/8	12	39	24	19
X1463 16/13-1/2 SS316	16	G1/2	14	41	24	19

Фитинг угловой с наружной резьбой Мод. X1500

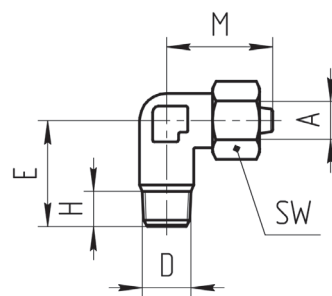

РАЗМЕРЫ						
Мод.	A	D	E	H	M	SW
X1500 4/2.5-M5 SS316	4	M5	20	4	20	10
X1500 4/2.5-M6 SS316	4	M6	20	4	20	10
X1500 4/2.5-1/8 SS316	4	R1/8	20	4	20	10
X1500 6/4-M5 SS316	6	M5	21	4	21	12
X1500 6/4-M6 SS316	6	M6	21	4	21	12
X1500 6/4-1/8 SS316	6	R1/8	21	7,5	21	12
X1500 6/4-1/4 SS316	6	R1/4	21	9,5	21	12
X1500 8/6-1/8 SS316	8	R1/8	22,5	7,5	22,5	14
X1500 8/6-1/4 SS316	8	R1/4	22,5	9,5	22,5	14
X1500 8/6-3/8 SS316	8	R3/8	22,5	10,5	22,5	14
X1500 8/6-1/2 SS316	8	R1/2	22,5	12,5	22,5	14
X1500 10/8-1/8 SS316	10	R1/8	25,5	7,5	22,5	16
X1500 10/8-1/4 SS316	10	R1/4	25,5	9,5	22,5	16
X1500 10/8-3/8 SS316	10	R3/8	25,5	10,5	22,5	16
X1500 10/8-1/2 SS316	10	R1/2	25,5	12,5	22,5	16
X1500 12/10-1/8 SS316	12	R1/8	29	7,5	29	19
X1500 12/10-1/4 SS316	12	R1/4	29	9,5	29	19
X1500 12/10-3/8 SS316	12	R3/8	29	10,5	29	19
X1500 12/10-1/2 SS316	12	R1/2	29	12,5	29	19
X1500 14/11-1/4 SS316	14	R1/4	31	9,5	31	21
X1500 14/11-3/8 SS316	14	R3/8	31	10,5	31	21
X1500 14/11-1/2 SS316	14	R1/2	31	12,5	31	21
X1500 16/13-3/8 SS316	16	R3/8	34	10,5	34	22
X1500 16/13-1/2 SS316	16	R1/2	34	12,5	34	22

ФИТИНГИ С НАКИДНОЙ ГАЙКОЙ ИЗ НЕРЖАВЕЮЩЕЙ СТАЛИ 316L

Фитинг угловой с наружной резьбой Мод. X1541

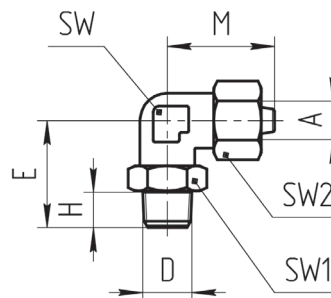

РАЗМЕРЫ								
Мод.	A	D	E	H	M	SW	SW1	SW2
X1541 4/2.5-M5 SS316	4	M5	20	4	20	9,2	10	10
X1541 4/2.5-M6 SS316	4	M6	20	4	20	9,2	10	10
X1541 4/2.5-1/8 SS316	4	R1/8	20	7,5	20	9,2	10	14
X1541 6/4-M5 SS316	6	M5	21	4	21	9,2	12	10
X1541 6/4-M6 SS316	6	M6	21	4	21	9,2	12	10
X1541 6/4-1/8 SS316	6	R1/8	21	7,5	21	9,2	12	14
X1541 6/4-1/4 SS316	6	R1/4	21	9,5	21	9,2	12	17
X1541 8/6-1/8 SS316	8	R1/8	22,5	7,5	22,5	11,2	14	14
X1541 8/6-1/4 SS316	8	R1/4	22,5	9,5	22,5	11,2	14	17
X1541 8/6-3/8 SS316	8	R3/8	22,5	10,5	22,5	11,2	14	21
X1541 8/6-1/2 SS316	8	R1/2	22,5	12,5	22,5	11,2	14	24
X1541 10/8-1/8 SS316	10	R1/8	25,5	7,5	22,5	13,2	16	17
X1541 10/8-1/4 SS316	10	R1/4	25,5	9,5	22,5	13,2	16	17
X1541 10/8-3/8 SS316	10	R3/8	25,5	10,5	22,5	13,2	16	21
X1541 10/8-1/2 SS316	10	R1/2	25,5	12,5	22,5	13,2	16	24
X1541 12/10-1/8 SS316	12	R1/8	29	7,5	29	15,5	19	17
X1541 12/10-1/4 SS316	12	R1/4	29	9,5	29	15,5	19	21
X1541 12/10-3/8 SS316	12	R3/8	29	10,5	29	15,5	19	21
X1541 12/10-1/2 SS316	12	R1/2	29	12,5	29	15,5	19	24
X1541 14/11-1/4 SS316	14	R1/4	31	9,5	31	20,6	21	24
X1541 14/11-3/8 SS316	14	R3/8	31	10,5	31	20,6	21	24
X1541 14/11-1/2 SS316	14	R1/2	31	12,5	31	20,6	21	24
X1541 16/13-3/8 SS316	16	R3/8	34	10,5	34	20,6	22	24
X1541 16/13-1/2 SS316	16	R1/2	34	12,5	34	20,6	22	24

Фитинг угловой с внутренней резьбой Мод. X1493

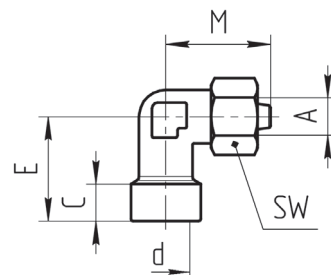

РАЗМЕРЫ						
Мод.	A	d	E	C	M	SW1
X1493 4/2.5-M5 SS316	4	M5	20	5	20	10
X1493 4/2.5-M6 SS316	4	M6	20	5	20	10
X1493 4/2.5-1/8 SS316	4	G1/8	20	8	20	10
X1493 6/4-M5 SS316	6	M5	21	5	21	12
X1493 6/4-M6 SS316	6	M6	21	5	21	12
X1493 6/4-1/8 SS316	6	G1/8	21	8	21	12
X1493 6/4-1/4 SS316	6	G1/4	21	11	21	12
X1493 8/6-1/8 SS316	8	G1/8	22,5	8	22,5	14
X1493 8/6-1/4 SS316	8	G1/4	22,5	11	22,5	14
X1493 8/6-3/8 SS316	8	G3/8	22,5	12	22,5	14
X1493 8/6-1/2 SS316	8	G1/2	22,5	14	22,5	14
X1493 10/8-1/8 SS316	10	G1/8	22,5	8	25,5	16
X1493 10/8-1/4 SS316	10	G1/4	22,5	11	25,5	16
X1493 10/8-3/8 SS316	10	G3/8	22,5	12	25,5	16
X1493 10/8-1/2 SS316	10	G1/2	22,5	14	25,5	16
X1493 12/10-1/8 SS316	12	G1/8	29	8	29	19
X1493 12/10-1/4 SS316	12	G1/4	29	11	29	19
X1493 12/10-3/8 SS316	12	G3/8	29	12	29	19
X1493 12/10-1/2 SS316	12	G1/2	29	14	29	19
X1493 14/11-1/4 SS316	14	G1/4	31	11	31	21
X1493 14/11-3/8 SS316	14	G3/8	31	12	31	21
X1493 14/11-1/2 SS316	14	G1/2	31	14	31	21
X1493 16/13-3/8 SS316	16	G3/8	34	12	34	22
X1493 16/13-1/2 SS316	16	G1/2	34	14	34	22

Фитинг тройник горизонтальный с наружной резьбой Мод. X1410

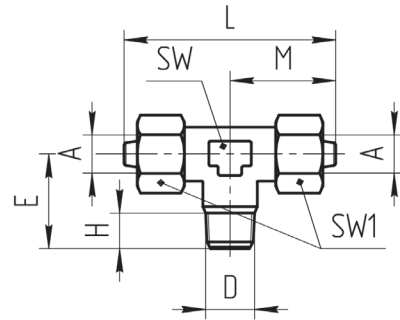

РАЗМЕРЫ

Мод.	A	D	E	H	M	L	SW	SW1
X1410 4/2.5-M5 SS316	4	M5	17	4	19	38	9,2	10
X1410 4/2.5-M6 SS316	4	M6	17	4	19	38	9,2	10
X1410 4/2.5-1/8 SS316	4	R1/8	20	7,5	20,7	41,4	9,2	10
X1410 6/4-M5 SS316	6	M5	17	4	20,7	41,4	9,2	12
X1410 6/4-M6 SS316	6	M6	17	4	20,7	41,4	9,2	12
X1410 6/4-1/8 SS316	6	R1/8	20	7,5	20,7	41,4	9,2	12
X1410 6/4-1/4 SS316	6	R1/4	21	9,5	20,7	41,4	9,2	12
X1410 8/6-1/8 SS316	8	R1/8	20	7,5	22,4	44,8	11,2	14
X1410 8/6-1/4 SS316	8	R1/4	22	9,5	22,4	44,8	11,2	14
X1410 8/6-3/8 SS316	8	R3/8	24	10,5	25,4	50,8	13,2	14
X1410 8/6-1/2 SS316	8	R1/2	24	12,5	25,4	50,8	13,2	14
X1410 10/8-1/8 SS316	10	R1/8	23	7,5	25,4	50,8	13,2	16
X1410 10/8-1/4 SS316	10	R1/4	24	9,5	25,4	50,8	13,2	16
X1410 10/8-3/8 SS316	10	R3/8	25	10,5	25,4	50,8	13,2	16
X1410 10/8-1/2 SS316	10	R1/2	27	12,5	25,4	50,8	13,2	16
X1410 12/10-1/8 SS316	12	R1/8	26	7,5	27,8	55,6	15,5	19
X1410 12/10-1/4 SS316	12	R1/4	27	9,5	27,8	55,6	15,5	19
X1410 12/10-3/8 SS316	12	R3/8	28	10,5	27,8	55,6	15,5	19
X1410 12/10-1/2 SS316	12	R1/2	30	12,5	27,8	55,6	15,5	19
X1410 14/11-1/4 SS316	14	R1/4	30	9,5	30,3	60,6	20,6	21
X1410 14/11-3/8 SS316	14	R3/8	31	10,5	30,3	60,6	20,6	21
X1410 14/11-1/2 SS316	14	R1/2	33	12,5	30,3	60,6	20,6	21
X1410 16/13-3/8 SS316	16	R3/8	33	10,5	33	66	20,6	22
X1410 16/13-1/2 SS316	16	R1/2	35	12,5	33	66	20,6	22

Фитинг тройник горизонтальный с внутренней резьбой Мод. X1453

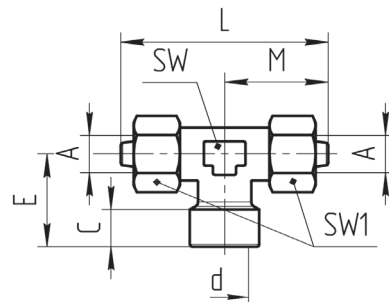

РАЗМЕРЫ								
Мод.	A	d	E	C	M	L	SW	SW1
X1453 4/2.5-M5 SS316	4	M5	17	5	19	38	9,2	10
X1453 4/2.5-M6 SS316	4	M6	17	5	19	38	9,2	10
X1453 4/2.5-1/8 SS316	4	G1/8	20	8	19	38	9,2	10
X1453 6/4-M5 SS316	6	M5	17	5	20,7	41,4	9,2	12
X1453 6/4-M6 SS316	6	M6	17	5	20,7	41,4	9,2	12
X1453 6/4-1/8 SS316	6	G1/8	20	8	20,7	41,4	9,2	12
X1453 6/4-1/4 SS316	6	G1/4	21	11	20,7	41,4	9,2	12
X1453 8/6-1/8 SS316	8	G1/8	20	8	22,4	44,8	11,2	14
X1453 8/6-1/4 SS316	8	G1/4	22	11	22,4	44,8	11,2	14
X1453 8/6-3/8 SS316	8	G3/8	24	12	25,4	50,8	13,2	14
X1453 8/6-1/2 SS316	8	G1/2	24	14	25,4	50,8	13,2	14
X1453 10/8-1/8 SS316	10	G1/8	23	8	25,4	50,8	13,2	16
X1453 10/8-1/4 SS316	10	G1/4	24	11	25,4	50,8	13,2	16
X1453 10/8-3/8 SS316	10	G3/8	25	12	25,4	50,8	13,2	16
X1453 10/8-1/2 SS316	10	G1/2	27	14	25,4	50,8	13,2	16
X1453 12/10-1/8 SS316	12	G1/8	26	8	27,8	55,6	15,5	19
X1453 12/10-1/4 SS316	12	G1/4	27	11	27,8	55,6	15,5	19
X1453 12/10-3/8 SS316	12	G3/8	28	12	27,8	55,6	15,5	19
X1453 12/10-1/2 SS316	12	G1/2	30	14	27,8	55,6	15,5	19
X1453 14/11-1/4 SS316	14	G1/4	30	11	30,3	60,6	20,6	21
X1453 14/11-3/8 SS316	14	G3/8	31	12	30,3	60,6	20,6	21
X1453 14/11-1/2 SS316	14	G1/2	33	14	30,3	60,6	20,6	21
X1453 16/13-3/8 SS316	16	G3/8	33	12	33	66	20,6	22
X1453 16/13-1/2 SS316	16	G1/2	35	14	33	66	20,6	22

Фитинг соединитель прямой навесной Мод. X1580

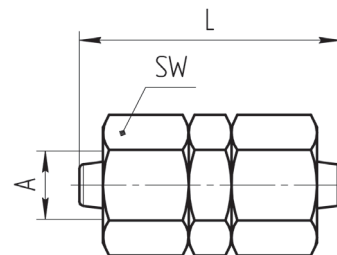

РАЗМЕРЫ			
Мод.	A	L	SW
X1580 4/2.5 SS316	4	32	10
X1580 6/4 SS316	6	34	12
X1580 8/6 SS316	8	35	14
X1580 10/8 SS316	10	39	16
X1580 12/10 SS316	12	43	19
X1580 14/11 SS316	14	47	21
X1580 16/13 SS316	16	51	22

Фитинг переходной прямой навесной Мод. X1580

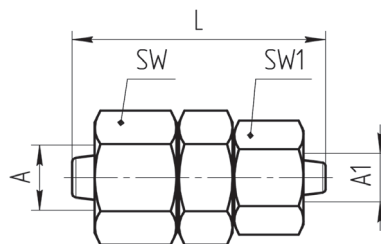

РАЗМЕРЫ

Мод.	A	A1	L	SW	SW1
X1580 6/4-4/2.5 SS316	6	4	22,5	12	10
X1580 8/6-6/4 SS316	8	6	31	14	12
X1580 10/8-8/6 SS316	10	8	34	16	14
X1580 12/10-10/8 SS316	12	10	39	19	16
X1580 14/11-12/10 SS316	14	12	43	21	19
X1580 16/13-12/10 SS316	16	12	45	22	19

Фитинг угловой навесной Мод. X1550

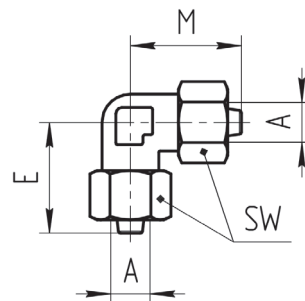
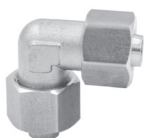

РАЗМЕРЫ

Мод.	A	E	M	SW
X1550 4/2.5 SS316	4	20	20	10
X1550 6/4 SS316	6	21	21	12
X1550 8/6 SS316	8	22,5	22,5	14
X1550 10/8 SS316	10	22,5	22,5	16
X1550 12/10 SS316	12	29	29	19
X1550 14/11 SS316	14	31	31	21
X1550 16/13 SS316	16	34	34	22

Фитинг тройник соединитель навесной Мод. X1540

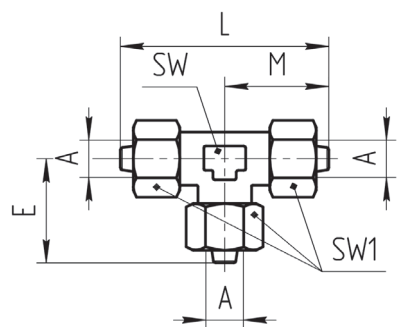
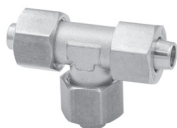

РАЗМЕРЫ

Мод.	A	E	M	L	SW	SW1
X1540 4/2.5 SS316	4	19	19	38	9,2	10
X1540 6/4 SS316	6	20,7	20,7	41,4	9,2	12
X1540 8/6 SS316	8	22,4	22,4	44,8	11,2	14
X1540 10/8 SS316	10	25,4	25,4	50,8	13,2	16
X1540 12/10 SS316	12	27,8	27,8	55,6	15,5	19
X1540 14/11 SS316	14	30,3	30,3	60,6	20,6	21
X1540 16/13 SS316	16	33	33	66	20,6	22

Фитинг тройник переходной навесной Мод. X1540

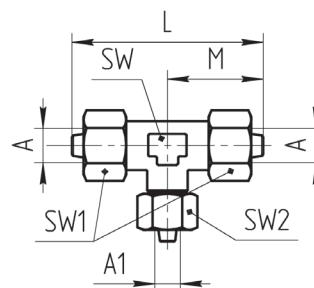
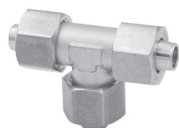

РАЗМЕРЫ

Мод.	A	A1	M	L	SW	SW1	SW2
X1540 6/4-4/2.5 SS316	6	4	20,7	41,4	9,2	12	10
X1540 8/6-6/4 SS316	8	6	22,4	44,8	11,2	14	12
X1540 10/8-8/6 SS316	10	8	25,4	50,8	13,2	16	14
X1540 12/10-10/8 SS316	12	10	27,8	55,6	15,5	19	16
X1540 14/11-12/10 SS316	14	12	30,3	60,6	20,6	21	19
X1540 16/13-12/10 SS316	16	12	33	66	20,6	22	19

Фитинг с серьгой в сборе Мод. X1525

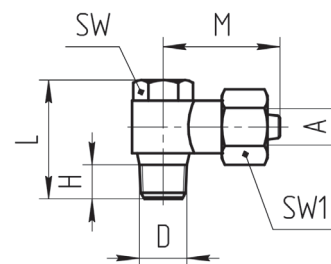

РАЗМЕРЫ

Мод.	A	D	H	M	L	SW	SW1
X1525 4/2.5-M5 SS316	4	M5	7,5	24	18,5	12	10
X1525 4/2.5-M6 SS316	4	M6	7,5	24	18,5	12	10
X1525 4/2.5-1/8 SS316	4	R1/8	7,5	24	25,5	12	10
X1525 6/4-M5 SS316	6	M5	7,5	24	18,5	12	12
X1525 6/4-M6 SS316	6	M6	7,5	24	18,5	12	12
X1525 6/4-1/8 SS316	6	R1/8	7,5	24	25,5	12	12
X1525 6/4-1/4 SS316	6	R1/4	9,5	29	27,5	14	12
X1525 8/6-1/8 SS316	8	R1/8	7,5	26	25,5	12	14
X1525 8/6-1/4 SS316	8	R1/4	9,5	30	27,5	14	14
X1525 8/6-3/8 SS316	8	R3/8	10,5	33	33	19	14
X1525 10/8-1/8 SS316	10	R1/8	9,5	26	25,5	14	16
X1525 10/8-1/4 SS316	10	R1/4	9,5	35	27,5	14	16
X1525 10/8-3/8 SS316	10	R3/8	10,5	36	33	19	16
X1525 10/8-1/2 SS316	10	R1/2	12,5	37	37,5	22	16
X1525 12/10-1/4 SS316	12	R1/4	9,5	36	27,5	14	19
X1525 12/10-3/8 SS316	12	R3/8	10,5	38	33	19	19
X1525 12/10-1/2 SS316	12	R1/2	12,5	40	37,5	22	19
X1525 14/11-1/4 SS316	14	R1/4	9,5	36	27,5	14	21
X1525 14/11-3/8 SS316	14	R3/8	10,5	38	33	19	21
X1525 14/11-1/2 SS316	14	R1/2	12,5	40	37,5	22	21
X1525 16/13-3/8 SS316	16	R3/8	10,5	40	33	19	22
X1525 16/13-1/2 SS316	16	R1/2	12,5	42	37,5	22	22

Гайка накидная Мод. X1703

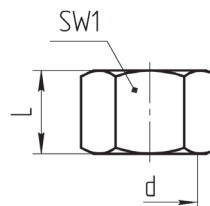

РАЗМЕРЫ			
Мод.	d	L	SW
X1703 4/2.5 SS316	M8x1	8	10
X1703 6/4 SS316	M10x1	10	12
X1703 8/6 SS316	M12x1	10	14
X1703 10/8 SS316	M14x1	13	16
X1703 12/10 SS316	M16x1	13,5	19
X1703 14/11 SS316	M18x1	15	21
X1703 16/13 SS316	M20x1	16	22

Фитинги Misco

Фитинг прямой с наружной резьбой Мод. X1511

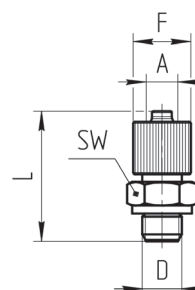

РАЗМЕРЫ					
Мод.	A	D	F	L	SW
X1511 4 M5 SS316	4	M5x0,8	7	16,5	7
X1511 6 M5 SS316	6	M5x0,8	9	17,5	8